

Framery Six™



The smart and soundproof office meeting room
shaping the workspace of tomorrow

framery



Framery Six is a smart meeting room for up to 6 people. This multifunctional soundproof meeting space is tailored for collaborative teamwork and enhanced for face-to-face and hybrid brainstorming sessions. With finely-tuned acoustics and top-notch soundproofing, it ensures privacy during discussions and virtual meetings. Framery Six's adaptive ventilation and automated lighting ensure your team can focus on what really matters and have a successful workday.

Framery Six / Product highlights



Workdays that flow with ease

Framery Six has been purposefully designed to make your workdays flow better. Find and book the pod in advance or on-the-fly from the Framery app. Or step inside and the pod automatically creates a reservation for you. Extend your reservation directly from the pod's touchscreen, or adjust your booking through the app.



Privacy you can trust

The fine-tuned acoustic structure provides A-Class soundproofing that allows the pod to be placed next to workstations without causing noise distractions to the user or to those outside of the pod. And echo-free interior acoustics make the pod a private, comfortable place for work and video calls.



Airflow that keeps you fresh

The pod recognizes when it's occupied, senses the temperature and humidity of the surroundings, and triggers adjustments to the airflow accordingly. Enhanced ventilation fully refreshes the air every minute, and ventilation can be easily adjusted through the pod's touchscreen.



Lighting that makes you feel good

Multiple automated light sources adapt to your needs, with preset lighting options to choose between work or video modes. Video-optimized lighting helps you shine on video calls. Adjustments can be made quickly and easily through the touchscreen display.

Framery Six / Tech features



1. A-CLASS SOUNDPROOFING

Guaranteed privacy with fine-tuned Class A speech level reduction of 30dB – and the industry's top ISO 23351-1 rating for office phone booths.

2. FRAMERY OFFICE SOUND MASKING SYSTEM™

The embedded system is based on patent-pending technology that reduces noise distractions and protects speech privacy in office environments by adding a subtle, unobtrusive background sound outside of the pod. This ambient background noise, similar to air flow, is specifically designed to blend in with the office's noise atmosphere – making sounds less intelligible and therefore less distracting.

3. ADAPTIVE VENTILATION

Proprietary design enables unparalleled ventilation with maximum airflow of 187 l/s – surpassing industry standards around the world.

4. TEMPERATURE & HUMIDITY SENSORS

Sensors inside the pod recognize the temperature and humidity of the office environment, and automatically optimize the airflow accordingly.

5. AUTOMATIC LIGHTING MODES

Multiple adjustable 4000K LED light sources allow you to seamlessly switch between video or work modes – or make manual adjustments for personalized illumination.

6. 8-INCH TOUCHSCREEN

An intuitive, 8-inch high-resolution touchscreen makes it easy to control pod settings, adjust lighting and airflow, and extend calendar reservations effortlessly.

7. AUTOMATIC UPGRADES

A built-in 4G connection enables automatic over-the-air software updates – initiated instantly and silently in the background.

8. MMWAVE RADAR PRESENCE DETECTION

Millimeter-wave radar sensors immediately detect when someone enters or leaves the pod, allowing lighting and ventilation to adjust accordingly.

Occupancy data is gathered and displayed through Framery Connect to provide information about when the pod is being used the most.

9. FRAMERY CONNECT™

Gain insights from occupancy data, initiate advanced bookability functionalities, and connect your Framery Six to the entire office to get valuable usage data needed to improve the layout and efficiency of your workplace.

Framery Six / Design details

Framery Six combines the best features of a larger meeting room in a convenient, modular package. The luxurious and spacious interior comes equipped with a proper-sized meeting table that can be complemented with your own choice of seats. The pod's low threshold enables easy access, and the minimalistic design approach uses carefully curated materials, making it a sustainable choice.



Framery Six is designed to bring teams together - whether you're meeting face-to-face or collaborating online. The space is tailored for collaborative teamwork, and enhanced for face-to-face and hybrid brainstorming sessions.



The optional gather zone outside of Framery Six creates an additional meeting area, featuring matching carpet and a convenient add-on rail where a whiteboard or additional display can be attached. This effectively doubles the amount of working space that Framery Six can offer.



The exterior occupancy lights show at a glance whether the pod is available or already taken.



The custom-designed table comfortably accommodates an entire team, and built-in power outlets and optional coat hooks support all your office accessories.



An optional interior whiteboard can be provided to make it even easier to collaborate participants during meetings.



Customize your pod to fit your workplace with hundreds of combinations of colors, fabrics, and high-quality materials to choose from.

Framery Six / Colors and finishes

EXTERIORS

	White RAL 9016 Ultramatt
	Black RAL 9005 Ultramatt
	Gray S 7500 - N Ultramatt
	Navy S 7020 - R90B Ultramatt
	Sand S 2010 - Y20R Ultramatt
	Powder Blue 3421-R86B Ultramatt
	Winter Moss S 7010-G10Y Ultramatt
	Blush 2728-R01B Ultramatt





CARPETS

	Light Gray Fletco carpets
	Dark Blue Fletco carpets
	Champagne Fletco carpets
	Grape Fletco carpets

TABLE TOPS

	White White laminate
	Black Black Laminate with anti-fingerprint surface
	Oak Veneer

INTERIORS

	Pure Gray Tonal #60123 Gabriel
	Arctic Blue Tonal #66185 Gabriel
	Sand Tonal #61180 Gabriel
	Rouge Tonal #64210 Gabriel

Design your own
on our website



MATERIALS AND FINISHES



EXTERIOR PANELS made from steel feature a powder-coated matt finish. The lightweight panels are joined together seamlessly, with elegant curves that create a timeless design.



INTERIOR PANELS made from high-quality and recycled polyester have a vibrant and dynamic look thanks to the mix of the two-colored fabric.

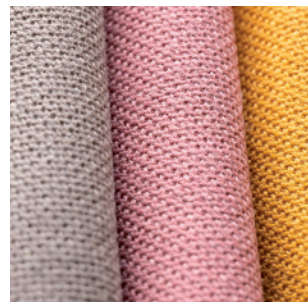

SEATING MATERIALS are a blend of superior New Zealand wool and polyamid that form a soft and rich texture. The extremely durable fabrics are both dirt and water repellent.



CARPET FLOORING is anti-static, stain resistant, and durable, giving the pod an overall soft look and finish.

Framery workplace technology / Set your office up for success

Framery's workplace technology suite streamlines workdays, elevates productivity, and enhances the entire workplace experience. Access real-time occupancy data, make data-driven decisions, book meeting spaces easily, and boost focus, privacy, and productivity throughout the office. Set up your workplace for the people who use it – making it easier than ever to get work done. And you can enjoy these benefits without any deployment costs.

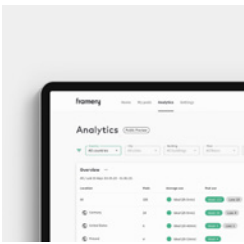

Framery Connect™

Use occupancy data to improve workspace efficiency. See which spaces are utilized, need attention, or go unused. Make data-driven decisions with real-time insights to optimize your office layout.



Framery Connect Sensor™

This compact sensor enhances Framery Connect by gathering usage data from any space in your workplace. Easily attach it to meeting rooms or collaborative areas to get a complete overview of how each space is utilized, with simple wireless connectivity for seamless data collection.

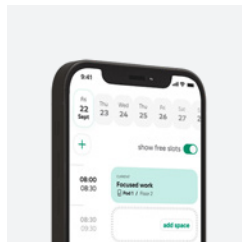

Framery App™

Manage your day with the Framery app – the easiest way to book pods and meeting spaces. Check availability instantly, save favorite spaces, and book on the go. Manage your workday all from your phone.

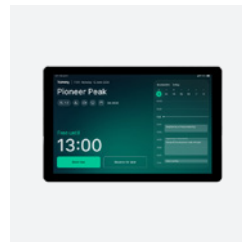

Framery Room Display™

The Framery room display is a booking system for all work and meeting spaces, showing real-time availability of the desired space and enabling instant on-site bookings for smooth scheduling. Integrated with work calendars, the Framery App™, and smart pods, it delivers a cohesive, synchronized office booking experience.



Framery Office Sound Masking System™

Improve workplace acoustics with Framery's sound masking system. It reduces noise distractions and protects speech privacy by adding subtle background sound, blending naturally with office noise.

Unparalleled support

Get instant support from a Framery specialist for any issues that may arise with your smart pods or other products.

Automatic updates

Instantly receive software updates through your smart pod's 4G connection to enable developments and services into the future.

Privacy assured

No identifiable user data is collected – only workspace occupancy information is tracked.

FRAMERY PLUS – EVERYTHING YOU NEED FOR A SUCCESSFUL WORKPLACE

Unlock all the tools and features your workplace needs to thrive with our subscription based Framery Plus™ – new smart pod customers receive a complimentary 1-year subscription.



Read more

Framery smart pods / Environmental data sheet

Framery's new smart pods set the standard in sustainability – with durability that is measured in decades, light-weight product structures, use of truly recyclable materials, and modularity that allows the life cycle of the products to be extended indefinitely. Framery participates in the Science Based Targets initiative, and has set emission reduction targets aligned with the goal of limiting global warming to 1.5°C compared to pre-industrial levels.



Optimal material use

Framery has achieved a 23% material reduction with its new line of products – which equals over 1 million kg of raw material annually – while increasing their level of performance compared to previous models. The carbon footprint in the manufacturing stage of the new products is 16% smaller on average. A change from plywood to steel as the main construction material also allows Framery to continue reducing its environmental impact and strive towards a 50% reduction in product CO2 emissions by 2028.



Production and waste management

All our pods are manufactured in Tampere, Finland using zero-emission electricity. Our factory logistics are operated on biogas and renewable diesel. The material efficiency rate of our production was 94.9% in 2022. Virtually no waste goes to landfill.



Environmental impact

We have conducted life cycle assessment studies for our products to measure their environmental

impacts. Alongside their carbon footprint, we also study other impacts such as resource depletion and water scarcity. The results are verified by an independent third party, and then published and registered as an EPD to provide stakeholders with reliable information on our products' environmental performance in a transparent way.



Product performance

The modular design of our pods facilitates a long product lifetime, and our customers typically use them for many years. The same pod can be used by one customer after another, enabling multiple life cycles and saving valuable resources. Thanks to their modular design, our pods are easy to disassemble, refurbish if needed, and reassemble at a new location. Our products are GREENGUARD Gold certified, and highly maintainable with easily available spare parts.



Transportation

Logistical hubs in Singapore and the USA reduces air freight, and allows us

to load our shipping containers more tightly. The products are made-to-order, and their modularity helps us achieve this with minimal impact.



Materials

To increase circularity, the pods contain mono-materials rather than composites for 100% recyclability. They also contain more recycled materials, including 20% recycled steel and aluminum, 29% recycled glass, and fabric featuring 80% recycled plastic. Framery will also be among the select few companies in the world pioneering the use of SSAB fossil-free steel in our products, starting as soon as the material becomes available in 2026.



Certificates and studies available

- Life Cycle Assessment (LCA)
- Environmental Product Declarations (EPD)
- Health Product Declarations (HPD) & Declare labels
- UL GREENGUARD Gold
- Contribution to Green Building Certifications such as LEED, BREEAM, SKA and WELL

100% END OF LIFE
RECYCLABILITY
*Framery One 95%



80 %
RECYCLED PET



20 %
RECYCLED STEEL



29%
RECYCLED GLASS



CERTIFIED
TEXTILES



CERTIFIED
WOOD

Framery Six™

Technical specifications

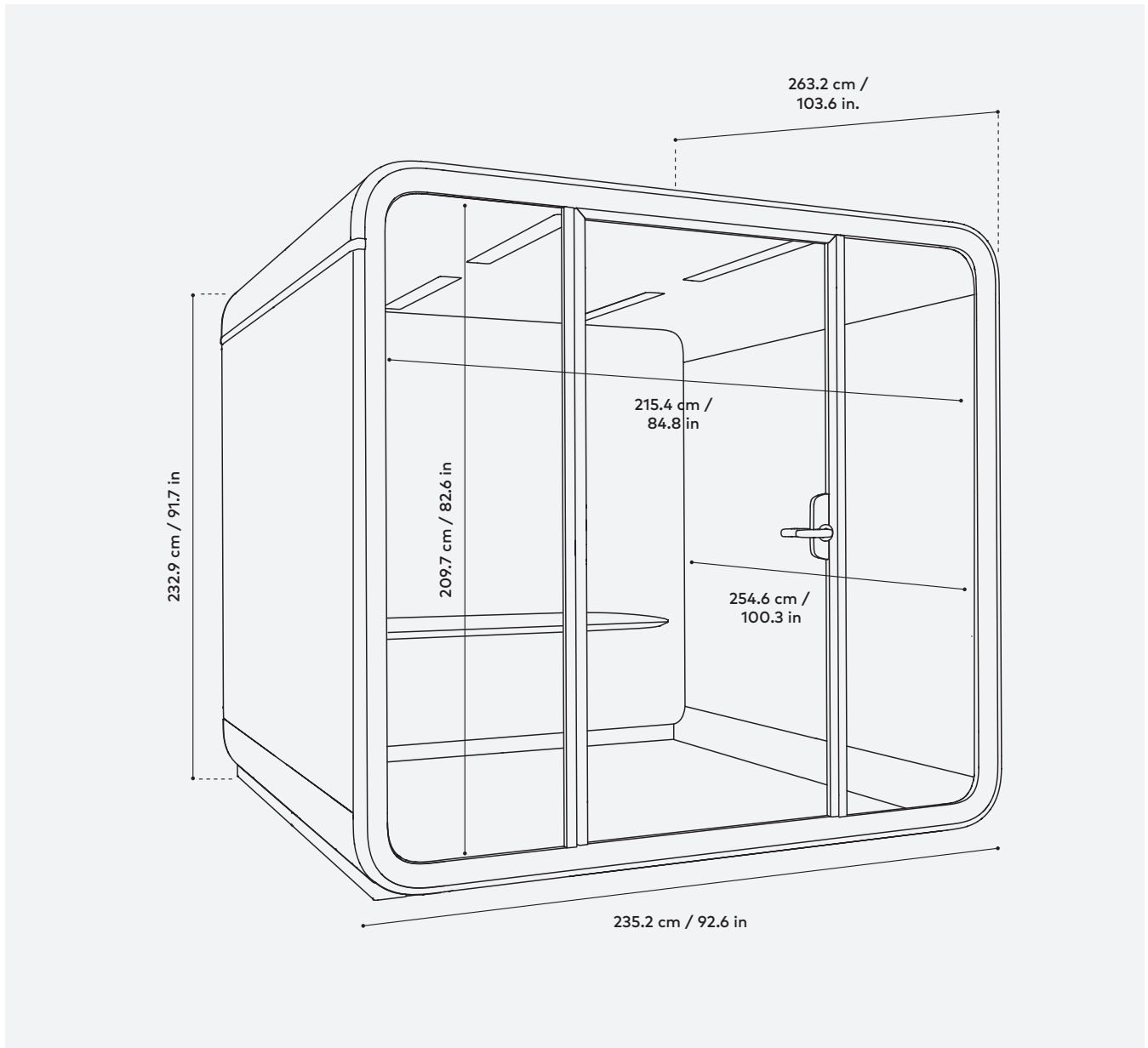

Performance

Speech level reduction: 30dB
Max airflow: 187 l/s
Low energy consumption: 145W

Sustainable design

Built to last for decades
Light-weight product structures
EOL 100% recyclable materials
Refurbishable & movable

Connectivity

Built-in 4G connection
Automatic software updates
Framery Connect digital services

Framery Six / Technical specifications

OVERVIEW

Soundproofing	CLASS A 30 DS,A (dB) reduction Speech level reduction DS,A (dB) is measured using ISO 23351-1. Pod can be placed next to workspaces without compromising privacy
Sound masking	FRAMERY OFFICE SOUND MASKING SYSTEM™ A pre-fitted sound masking system improves the soundscape of the office outside the pods with an effective radius of 5 m / 16 ft
Ventilation	MAXIMUM AIRFLOW 187 l/s, 397 CFM (674.6 m³/h) DEFAULT AIRFLOW 149 l/s, 316 CFM (536 m³/h) when in use. After use, the pod refreshes itself with a higher ventilation speed. ON STANDBY MODE 76 l/s, 161 CFM (274 m³/h) ADJUSTABLE DIRECTIONAL AIRFLOW Choose between direct and indirect airflow
Lighting	CEILING LIGHT Color temperature 4000K, illuminance up to 500lux on the table top. VIDEO LIGHT Color temperature 4000K, illuminance up to 350lux on the user's face. PRE-SET LIGHTING MODES Standard mode & Video call mode. The lighting can also be adjusted manually
Presence detection	SENSOR TECHNOLOGY mmWave radar
Dimensions	EXTERIOR with air filter housing 232.9 × 235.2 × 263.2 cm / 91.7 × 92.6 × 103.6 in (h, w, d) DOORWAY 209.7 × 96.6 cm / 82.6 × 38 in (h, w) WEIGHT 718 kg / 1582.9 lb (Framery Six Base 693 kg / 1527.8 lb) THRESHOLD 1.25 cm / 0.5 in
Touchscreen location	On the table (Framery Six Base: on the wall)
Connectivity	Framery smart pods gather anonymous occupancy data, measuring when and how often spaces are used. Users in the space cannot be identified and no personally identifiable data is collected. The anonymous data is transferred via built-in 4G connectivity, or through a Wi-Fi connection and compiled and shown in the Framery Connect platform. WLAN Wi-Fi 802.11 a/b/g/n/ac 2.4&5 GHz

DIMENSIONS / MAIN VIEW

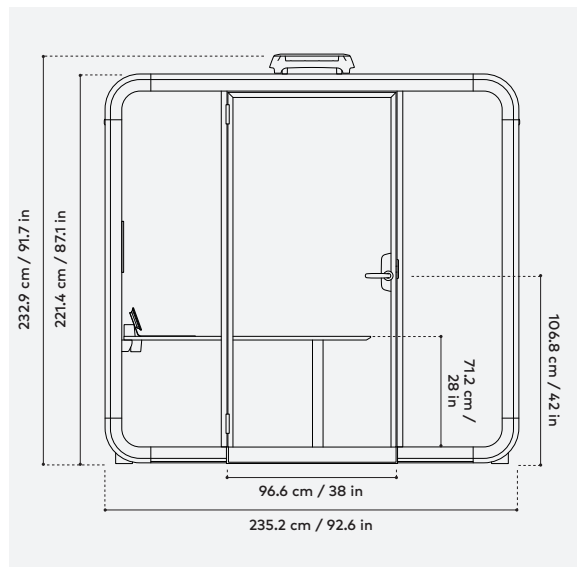
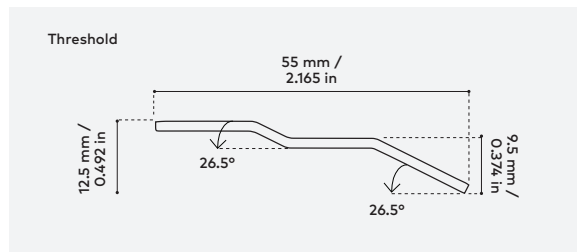
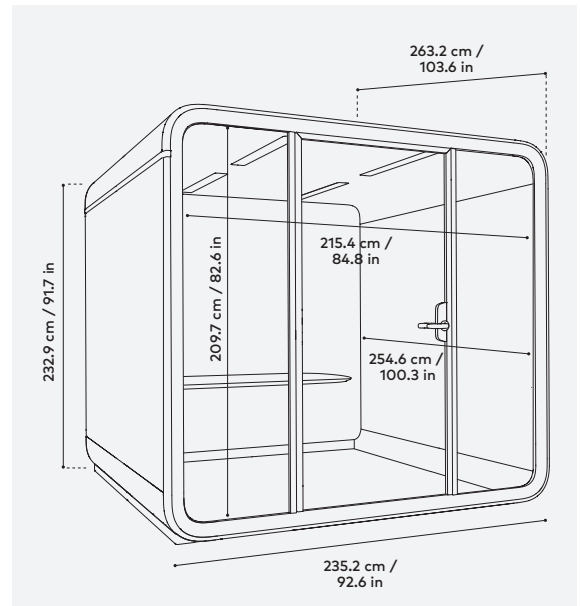

Framery Six is UL GREENGUARD GOLD certified



Framery Six shipped in North America is UL 962 listed

Framery Six / Technical specifications

MATERIALS

Exterior & structure	EXTERIOR PANELS Powder coated matt steel panels FRAMES Structure matt black aluminum. DOOR FRAME Structure matt black aluminum GLASS Sound control laminated glass (4 + 4 mm / 0.16 + 0.16 in) CHASSIS Light steel and PET sound-absorbing structure HANDLE Custom designed black metal
Interior materials	INTERIOR PANELS PET sheets laminated with recycled polyester fabric UPHOLSTERY FABRIC Gabriel Tonal CARPET Antistatic and stain resistant low loop pile carpet. TABLE Table top is birch plywood laminated with white, black anti-fingerprint, or oak veneer. TABLE LEG Structure black metal
Furniture dimensions	TABLE 94 cm x 140 cm / 37 in x 55.1 in (w, d) Fixed height from floor 71.2 cm / 28 in MAX LOAD FOR THE TABLE 60 kg / 131 lb
Optional accessories	INTERIOR WHITEBOARD 102.3 x 206.3 cm / 40.3 x 81.2 in (h, w) MONITOR WALL MOUNT Maximum monitor size 50". Maximum weight 30 kg / 66 lbs with flat VESA 100 x 100, 200 x 100, 200 x 200, 300 x 200, 300 x 300, 400 x 200, 400 x 300 or 400 x 400 mounting surface. Monitor not included. Possibility to mount on both walls. COAT HOOKS Structure black metal EXTERIOR TABLET MOUNT With easy set-up. GATHER ZONE Includes the same whiteboard and monitor wall mount as interior, and additional exterior carpet

DIMENSIONS / TOP VIEW

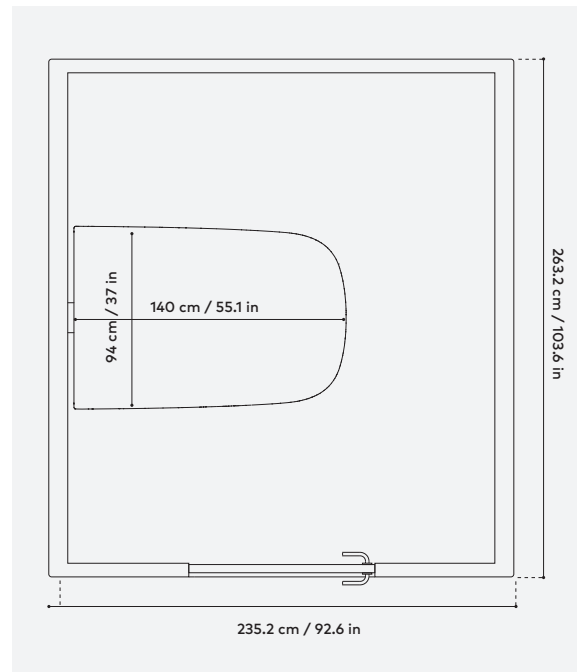

SAFETY

Fire safety	No fire hazardous materials are used in Framery pods. The fire safety of all surface materials, upholstery and acoustics materials of our products are tested and classified by either national or international standards. Framery provides additional safety measurements to adhere to local regulatory requirements
Seismic safety	A seismic anchoring kit for a pod is available for the seismic regions. The kit consists of brackets that further reinforce the pod structure to withstand heavy seismic forces

Framery Six / Technical specifications

POWER AND SPACE REQUIREMENTS

Power

FRAMERY SIX ESSENTIALS OUTLETS

2 x on-table outlets, 2 x under-table power outlets, 2 x in-table USB-C PD charge ports (65 W). Optional 2 x under-table power outlets. Optional in-table outlets (max 2) 0-1 x HDMI port, 0-2 x LAN ports (with cables)

FRAMERY SIX LITE OUTLETS 2 x on-table power outlets, 2 x under-table power outlets. Optional 2 x under-table power outlets. Optional in-table outlets (max 4) 0-2 x USB-C PD charge ports (65 W), 0-1 x HDMI port, 0-4 x LAN ports (with cables)

FRAMERY SIX BASE OUTLETS 4 x power outlets on the same side of the pod as the touchscreen. Optional outlets (max 4): 0-2 x USB-C PD charge ports (65 W), 0-4 x LAN ports (with cables)

The location of power outlets may vary based on country regulations.

POWER CONSUMPTION Default settings 145W. Highest settings 202W. Standby mode 28W. **INPUT** 100-240 VAC, 10 A*, 50-60 Hz. **OUTPUT AC (POWER OUTLET)** 100- 40 VAC (8 A max) 50-60 Hz. **OUTPUT USB-C PD CHARGE PORT** 65W

*In India power outlet type 16A is used

Space requirements

DOOR OPENING RATIO 180°

Door handedness

Left-handed by default (can also be installed right-handed)

Operating space

From back to front (pod depth + doorway) 359.8 cm / 141.6 in. Room height requirement 238 cm / 93.7 in

Installation space

Installation requires 50 cm / 19.7 in of free space around the pod. Room height requirement 238 cm / 93.7 in.

Movability

Relocate the pod without the need for disassembly by adding casters with a movability kit. Compatible with Framery Four and Six. The kit is reusable. Multiple pods can be moved with one kit

SHIPPING CRATE DIMENSIONS

Crate 1

SIZE 222 x 89 x 149 cm / 87.4 x 35 x 58.7 in (l, w, h). **WEIGHT** 392 kg / 864 lb

Crate 2

SIZE 224 x 113 x 116 cm / 88.2 x 44.5 x 46.7 in (l, w, h). **WEIGHT** 505 kg / 1113 lb

Crate 1 is stacked on top of Crate 2

DIMENSIONS / POWER CORD SPECIFICATIONS

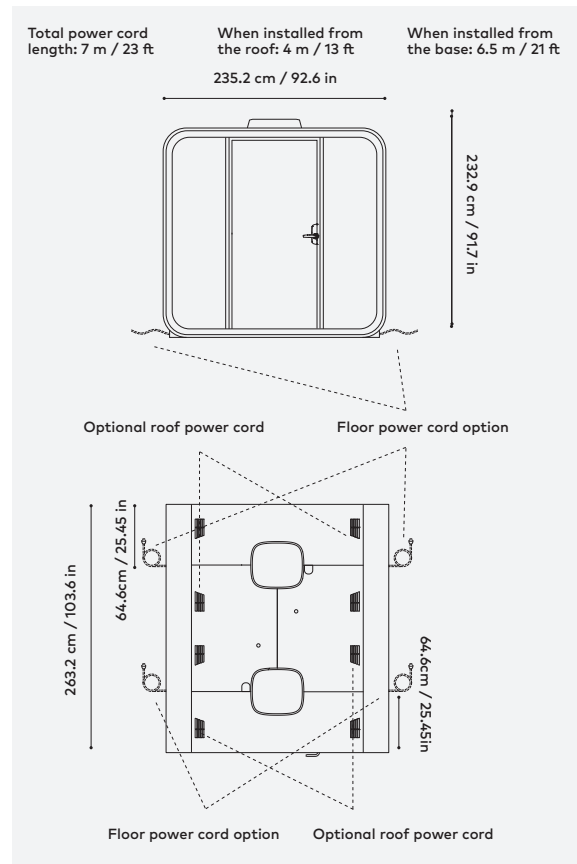

DIMENSIONS / OPERATING SPACE

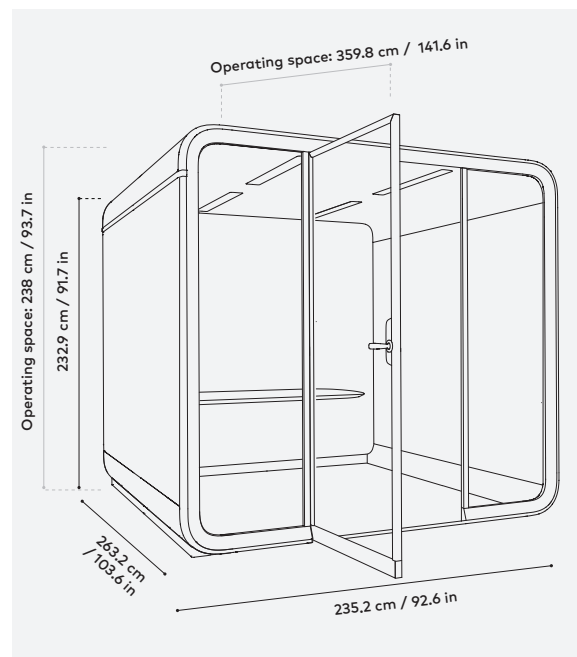

For the doers,
leaders, thinkers,
dreamers, creators,
teams, pioneers
and innovators.
**For people who
get it done.**